



**Dichiarazione CE di conformità**  
*EC declaration of conformity*

Torino, 1/1/2010

REER SpA  
via Carcano 32  
10153 – Torino  
Italy

dichiara che le barriere fotoelettriche **VISION** sono Dispositivi Elettrosensibili di Sicurezza (ESPE) di :

- **Tipo 2** (secondo la Norma **CEI EN 61496-1:2005; CEI EN 61496-2:2007**)
- **SIL 2** (secondo la Norma **CEI EN 61508:2002**)
- **SILCL 2** (secondo la Norma **CEI EN 62061:2005 + CEI EN 62061/EC2:2008**)
- **PL d** (secondo la Norma **UNI EN ISO 13849-1:2008**)

declares that the **VISION** photoelectric safety barriers are :

- **Type 2** (according the Standard **IEC 61496-1:2004; IEC 61496-2:2006**)
- **SIL 2** (according the Standard **IEC 61508:1998**)
- **SILCL 2** (according the Standard **IEC 62061:2005**)
- **PL d** (according the Standard **ISO 13849-1:2006**)

Electro-sensitive Protective Equipments (ESPE)

realizzati in conformità alle seguenti Direttive Europee:  
*complying with the following European Directives:*

- **2006/42/CE** "Direttiva Macchine"  
*"Machine Directive"*
- **2004/108/CE** "Direttiva Compatibilità Elettromagnetica"  
*"Electromagnetic Compatibility Directive"*
- **2006/95/CE** "Direttiva Bassa Tensione"  
*"Low Voltage Directive"*

e sono identiche all'esemplare esaminato ed approvato con esame di tipo CE da:  
*and are identical to the specimen examined and approved with a CE - type approval by:*

**TÜV SÜD Rail GmbH – Ridlerstrasse 65 – D-80339 – Muenchen – Germany**

**Carlo Pautasso**  
Direttore Tecnico  
*Technical Director*

**Giancarlo Scaravelli**  
Presidente  
*President*

*PHOTOELECTRIC  
SAFETY  
BARRIER*

**VISION**

***INSTALLATION USE AND MAINTENANCE***

**TABLE OF CONTENTS**

INTRODUCTION.....	2
OPERATION.....	3
INSTALLATION.....	4
POSITION.....	5
SAFETY DISTANCE CALCULATION.....	6
VERTICAL POSITION OF THE BARRIER.....	6
VERTICAL POSITION OF THE BARRIER.....	7
HORIZONTAL POSITION OF THE BARRIER.....	8
ELECTRICAL CONNECTIONS.....	9
MULTIPLE SYSTEMS.....	13
DISTANCE BETWEEN REFLECTING SURFACES.....	13
USE OF DEFLECTION MIRRORS.....	15
MECHANICAL ASSEMBLY AND OPTIC ALIGNMENT.....	16
OPERATION AND TECHNICAL DATA.....	17
SIGNALS.....	17
TEST FUNCTION.....	18
OUTPUTS STATUS.....	18
TECHNICAL SPECIFICATIONS.....	19
DIMENSIONS ( <i>in mm</i> ).....	21
CHECKOUTS AND MAINTENANCE.....	23
TROUBLESHOOTING.....	24
SPARE PARTS.....	26
GUARANTEE.....	27



***This symbol stands by a very important warning concerning the safety of persons. Its non-observance can cause a very serious risk for the exposed personnel.***

## INTRODUCTION

The VISION photoelectric barrier is a multi-beam optoelectronic safety system. It belongs to the family of Type 2 electrosensitive devices for the protection of personnel exposed to risks arising from the use of hazardous machinery or plant.

The VISION barrier, which consists of an Emitter and a Receiver, is a type 2 optoelectronic safety device according to standards IEC 61496-1 and IEC 61496-2.

VISION is available in two different families of models depending on the maximum working range : 6m (**VL** models) and 16m (**VH** models).

The two built-in safe static PNP outputs enable the barrier to be connected to the AD SR safety modules or to a safety PLC or to another control system that satisfies the specific requirements and safety level of the application.

VISION is ideal for protecting:

Machinery for product handling such as conveyors, palletizing, collating machines; packaging and wrapping devices; automated assembly lines; automated warehousing.



***If necessary, for any safety-related problems contact the competent safety authorities or industrial associations in the country of use.***



***For applications in the food industry, please contact the manufacturer to ensure that the barrier contains materials that are compatible with the chemical agents utilized.***

The protective function of the optoelectronic devices is not effective in the following cases:



***If the machine stopping control cannot be actuated electrically and it is not possible to stop all dangerous machine movements immediately and at any time during the operating cycle.***







***If the machine generates dangerous situations due to material being expelled or falling from overhead.***



## INSTALLATION



Before installing the VISION safety system, make sure that:

-  ***The safety system is only used as a stopping device and not as a machine control device.***
-  ***The machine control can be actuated electrically.***
-  ***All dangerous machine movements can be interrupted immediately. In particular, the machine stopping times must be known and, if necessary, measured.***
-  ***The machine does not generate dangerous situations due to materials projecting or falling from overhead; if that is not the case, additional mechanical guards must be installed.***
-  ***The minimum dimensions of the object that must be intercepted are greater than or equal to the resolution of the specific model.***

Knowledge of the shape and dimensions of the dangerous area enables the width and height of the relative access area to be calculated.

-  ***Compare these dimensions with the maximum working range and the height of the protected area in relation to the specific model.***

The general instructions set out below must be taken into consideration before placing the safety device in position.

-  ***Make sure that the temperature of the environment in which the system is to be installed is compatible with the temperature parameters contained in the technical data sheet.***
-  ***Do not install the Emitter and Receiver close to bright or high-intensity flashing light sources.***
-  ***Certain environmental conditions may affect the monitoring capacity of the photoelectric devices. In order to assure correct operation of equipment in places that may be subject to fog, rain, smoke or dust, the appropriate correction factors  $C_f$  should be applied to the maximum working range values. In these cases:***

$$P_u = P_m \times C_f$$

***where  $P_u$  and  $P_m$  are, respectively, the working and maximum range in meters.***

The recommended Cf factors are shown in the table below:

ENVIRONMENTAL CONDITION	CORRECTION FACTOR Cf
Fog	0.25
Steam	0.50
Dust	0.50
Dense fumes	0.25

***If the device is installed in places that are subject to sudden changes in temperature, the appropriate precautions must be taken in order to prevent the formation of condensation on the lenses, which could have an adverse effect on monitoring.***

**POSITION**

The position of the VE Emitter and the VR Receiver must prevent access to the danger zone from above, below and from the sides, unless at least one of the optical beams has been intercepted. Some useful information regarding the correct position of the barrier is shown in the figure below.

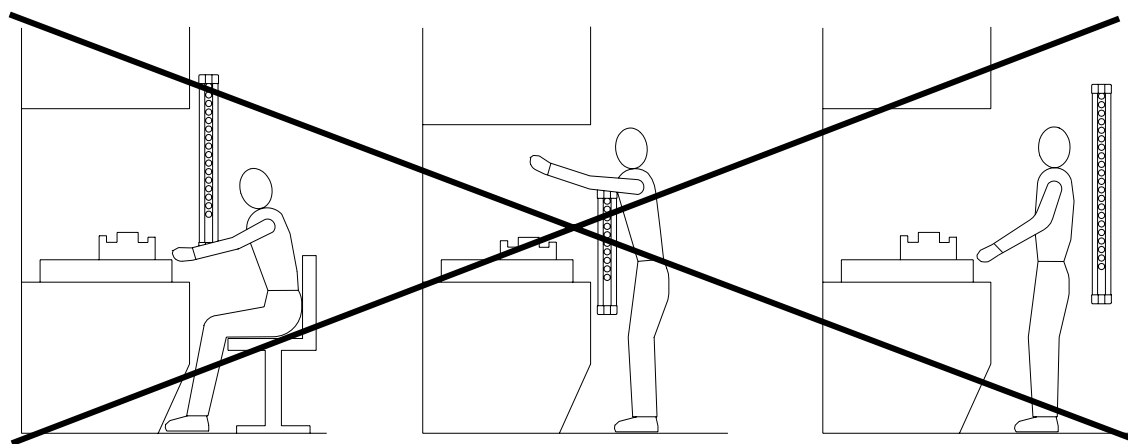

**Incorrect positioning of barrier**

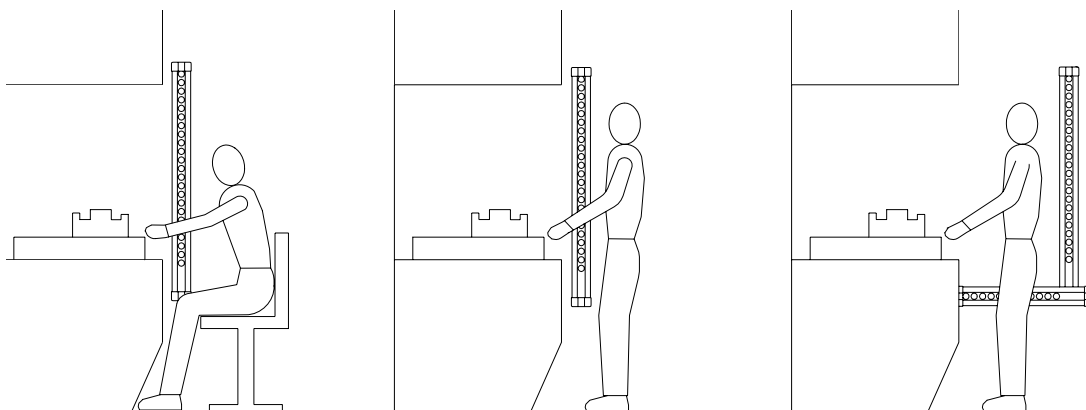

**Correct positioning of barrier**

**Figure 2**

**SAFETY DISTANCE CALCULATION**

The barrier must be installed at a distance that is greater than or equal to the **minimum safety distance S**, so that a dangerous point can only be reached after all hazardous machine movements have stopped (Figure 3).

According to European standard EN999, the minimum safety distance **S** must be calculated using the following formula:

$$S = K (t_1 + t_2 + t_3) + C$$

where:

<b>S</b>	<i>minimum safety distance</i>	mm
<b>K</b>	<i>approach speed of object to the dangerous area</i>	mm/sec
<b>t<sub>1</sub></b>	<i>response time of the safety barrier in seconds</i>	sec
<b>t<sub>2</sub></b>	<i>response time of the safety interface in seconds (e.g. PLC or safety module*)</i>	sec
<b>t<sub>3</sub></b>	<i>machine response time, in seconds, meaning the time required for the machine to interrupt the dangerous movement following transmission of the stop signal</i>	sec
<b>c</b>	<i>additional distance</i>	mm

\* t<sub>2</sub> AD SR1 = 20 msec (refer to the technical manual of each single safety module, if different from AD SR1).

 **The non-observance of the correct safety distance reduces or cancels the protective action of the light curtain.**

 **If the position of the barrier does not prevent the operator from having access to the dangerous area without being detected, additional mechanical guards must be installed to complete the system.**

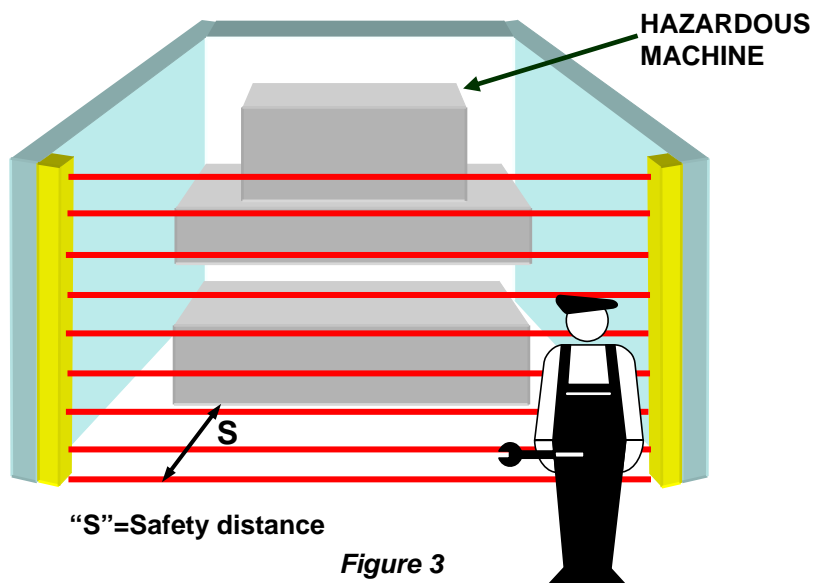

**Figure 3**

**VERTICAL POSITION OF THE BARRIER**



**20 mm resolution models.**

*These models are suitable for the protection of fingers.*



**30 mm and 40 mm resolution models.**

*These models are suitable for the protection of hands.*

The minimum safety distance **S** is calculated according to the following formula:

$$S = 2000(t_1 + t_2 + t_3) + 8(D-14)$$

(D=resolution)

This formula is valid for distances **S** between 100 and 500 mm. If this formula results in **S** being greater than 500 mm, the distance can be reduced to a minimum of 500 mm by means of the following formula:

$$S = 1600(t_1 + t_2 + t_3) + 8(D-14)$$

If, due to the specific configuration of the machine, the dangerous area can be accessed from above, the highest beam of the barrier must be at a height **H** of at least 1800 mm from the base **G** of the machine.

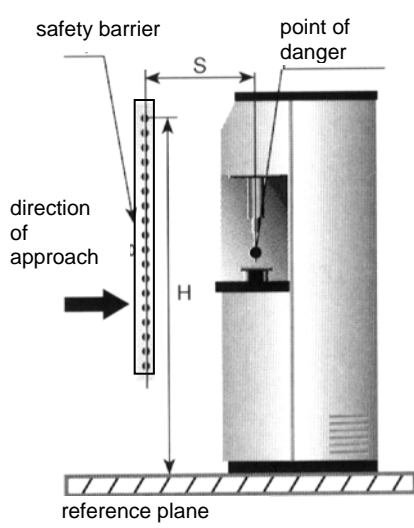

**Figure 4**



**50 mm and 90 mm resolution models.**

*These models are suitable for the protection of arms or legs and must not be used to protect fingers or hands.*

The minimum safety distance **S** is calculated according to the following formula:

$$S = 1600(t_1 + t_2 + t_3) + 850$$

The height **H** of the highest beam from the base **G** must never be less than 900 mm, while the height of the lowest beam **P** must never be more than 300 mm.

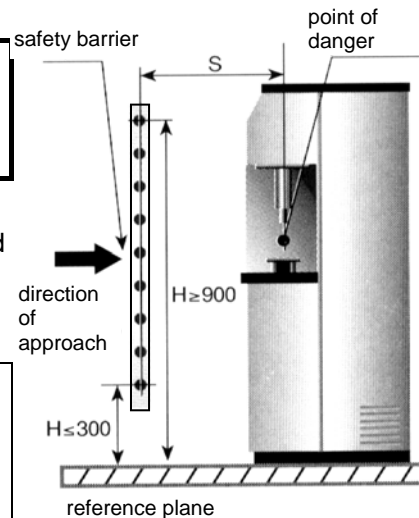

**Figure 5**



**Multibeam Models.**



**These models are suitable for the protection of the entire body and must not be used to protect arms or legs.**

The minimum safety distance **S** is calculated according to the following formula:

$$S = 1600 (t_1 + t_2 + t_3) + 850$$

**→** The recommended height **H** from the base (G) must be the following:

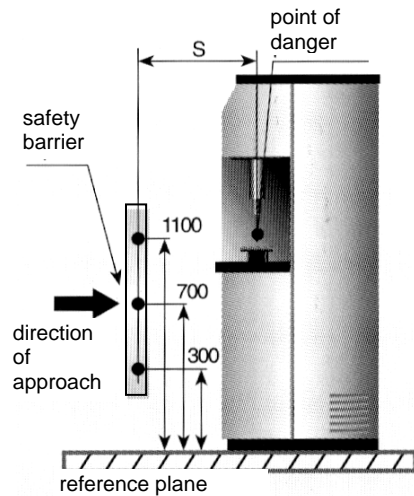

**Figure 6**

MODEL	BEAMS	Recommended Height H (mm)
V2BL / V2BH	2	400 – 900
V3BL / V3BH	3	300 – 700 – 1100
V4BL / V4BH	4	300 – 600 – 900 - 1200

**HORIZONTAL POSITION OF THE BARRIER**

When the object's direction of approach is parallel to the floor of the protected area, the barrier must be installed so that the distance between the outer limit of the dangerous area and the most external optical beam is greater than or equal to the minimum safety distance **S** calculated as follows:

$$S = 1600(t_1 + t_2 + t_3) + 1200 - 0.4H$$

where **H** is the height of the protected surface from the base of the machine;

$$H = 15(D-50)$$

(D=resolution)

**In this case, H must always be less than 1 meter. In any case the following condition must be respected :**

$$1200 - 0.4H \geq 850$$

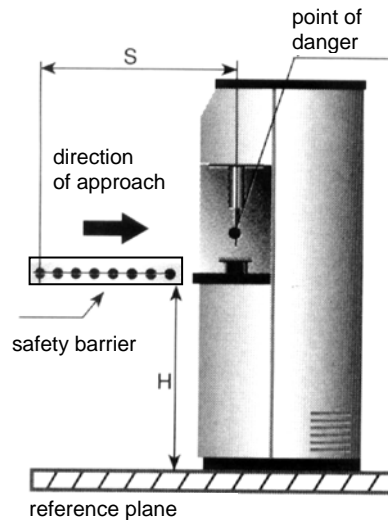

**Figure 7**

## ELECTRICAL CONNECTIONS

---

### WARNINGS

Before making the electrical connections, make sure that the supply voltage complies with that specified in the technical data sheet.



***Emitter and Receiver units must be supplied with 24Vdc±20% power.***



***The external power supply must comply with the standard EN 60204-1.***

The electrical connections must be made according to the diagrams in this manual. In particular, do not connect other devices to the connectors of the Emitter and Receiver.

To guarantee reliability of operation, when using a diode jumper supply unit, its output capacity must be at least 2000µF for each absorbed **A**.

### Connector pins

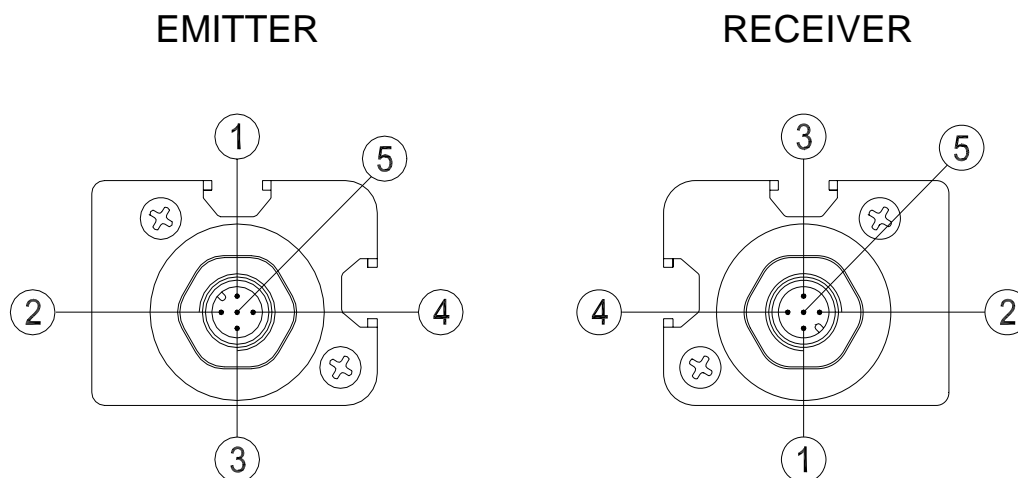

Figure 8

EMITTER			
NUMBER	COLOR	NAME	MEANING
1	Brown	24 VDC	Power supply (positive)
2	White	TEST	- Operation without TEST (+24VDC) - TEST control (Transition +24VDC -> 0VDC or open circuit)
3	Blue	0 VDC	Power supply (negative)
4	Black	N.C.	N.C.
5	Grey	PE	Ground connection

Table 1



**If the TEST function is not required by the application, connect pin 2 of the emitter to +24Vdc.**

RECEIVER			
NUMBER	COLOR	NAME	MEANING
1	Brown	24 VDC	Power supply (positive)
2	White	OSSD1	Static output No. 1 (PNP active high)
3	Blue	0 VDC	Power supply (negative)
4	Black	OSSD2	Static output No. 2 (PNP active high)
5	Grey	PE	Ground connection

Table 2



**Example of connection of the VISION barrier to the REER AD SR1 safety module (with internal contactors in series)**

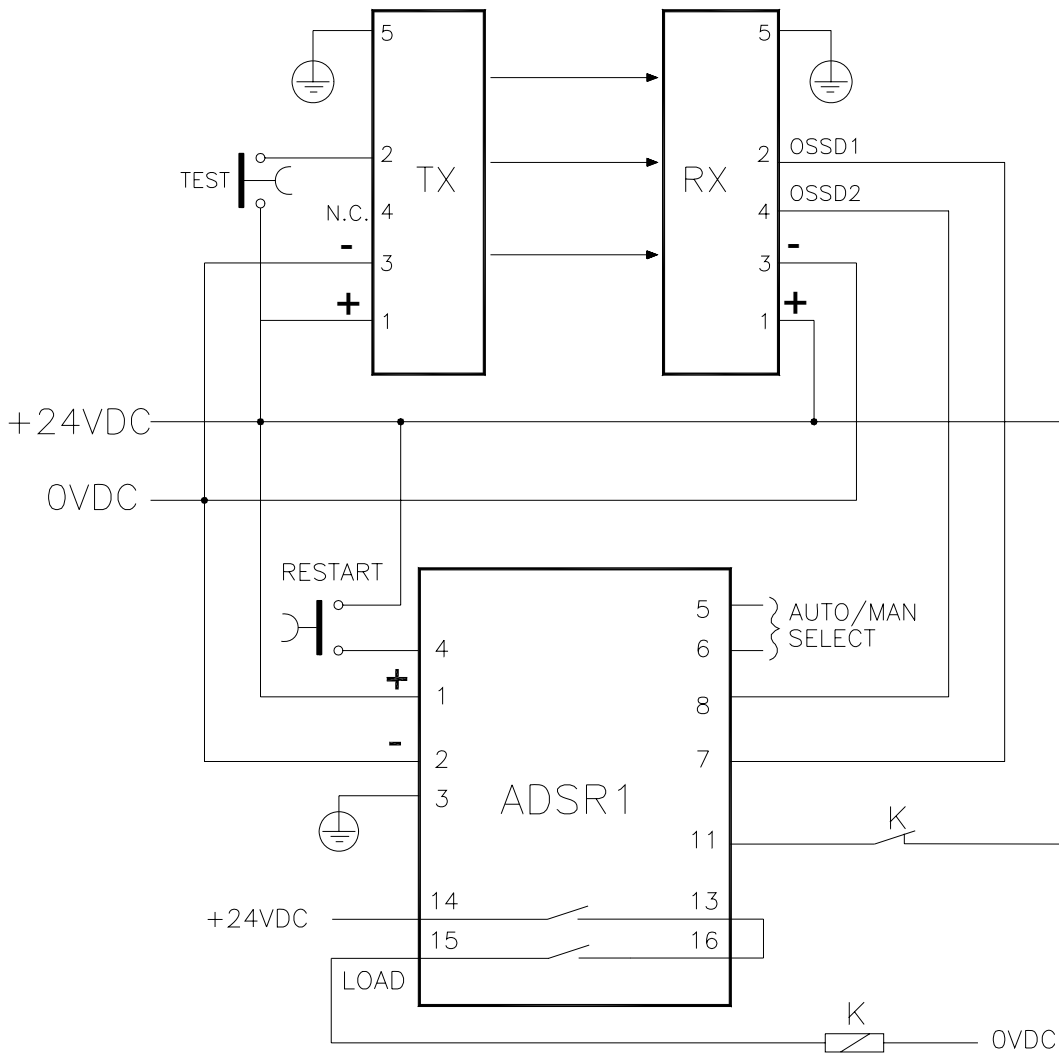

**Figure 10**

**⚠ In this configuration the test is compulsory (with frequency determined by risk analysis).**

**Warnings regarding the connection cables**

- For connections over 50 m long, use cables with a cross-section area of 1 mm<sup>2</sup>.
- The power supply to the barrier should be kept separate from that to other electric power equipment (electric motors, inverters, frequency converters) or other sources of disturbance.
- Connect the Emitter and the Receiver to the ground outlet.
- The connection cables must follow a different route to that of the other power cables.

**MULTIPLE SYSTEMS**

When more than one VISION system is used, precautions must be taken to avoid optical interference between them: install units so that the beam emitted by the Emitter of one system can only be received by the relative Receiver.

Figure 11 illustrates some examples of correct positioning when two photoelectric systems are installed. Incorrect positioning could generate interference, and may result in malfunctioning.

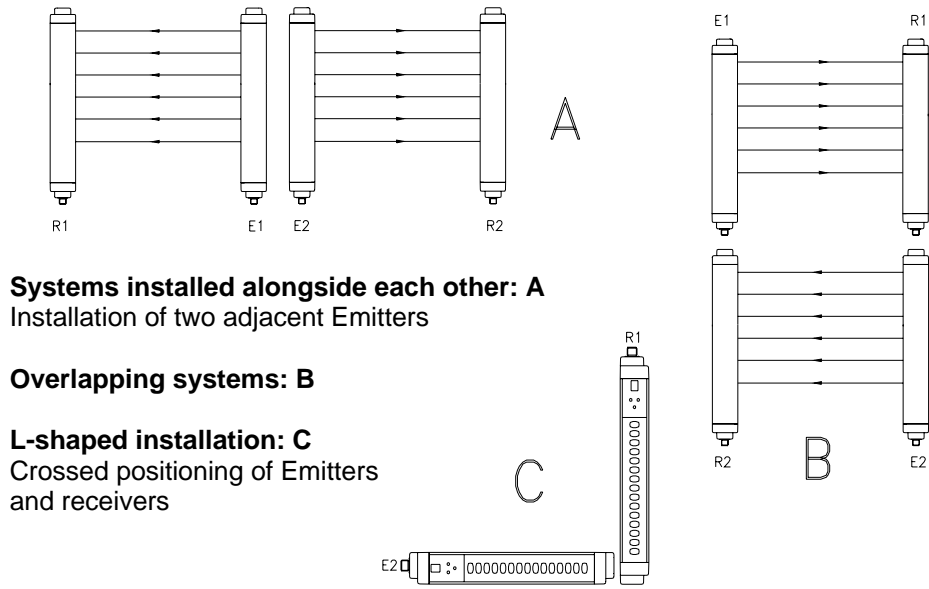

**Systems installed alongside each other: A**  
Installation of two adjacent Emitters

**Overlapping systems: B**

**L-shaped installation: C**  
Crossed positioning of Emitters and receivers

**Figure 11**

If it is possible (depending on the application), we suggest to utilize the models with a working range of 6m.

**DISTANCE BETWEEN REFLECTING SURFACES**

The presence of reflecting surfaces in proximity of the photoelectric barrier may generate spurious reflections that prevent monitoring. With reference to Figure 12, object **A** is not detected because surface **S** reflects the beam and closes the optical path between the Emitter and Receiver.

A minimum distance **d** must therefore be maintained between any reflecting surfaces and the protected area. The minimum distance **d** must be calculated according to the distance **l** between the Emitter and the Receiver.

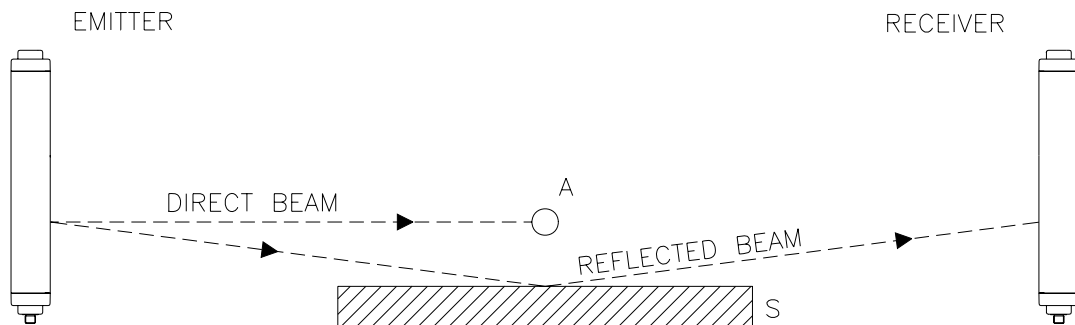

**Figure 12**

Figure 13 illustrates the values for the minimum distance  $d$  that must be maintained when the distance  $l$  between the Emitter and Receiver is changed.

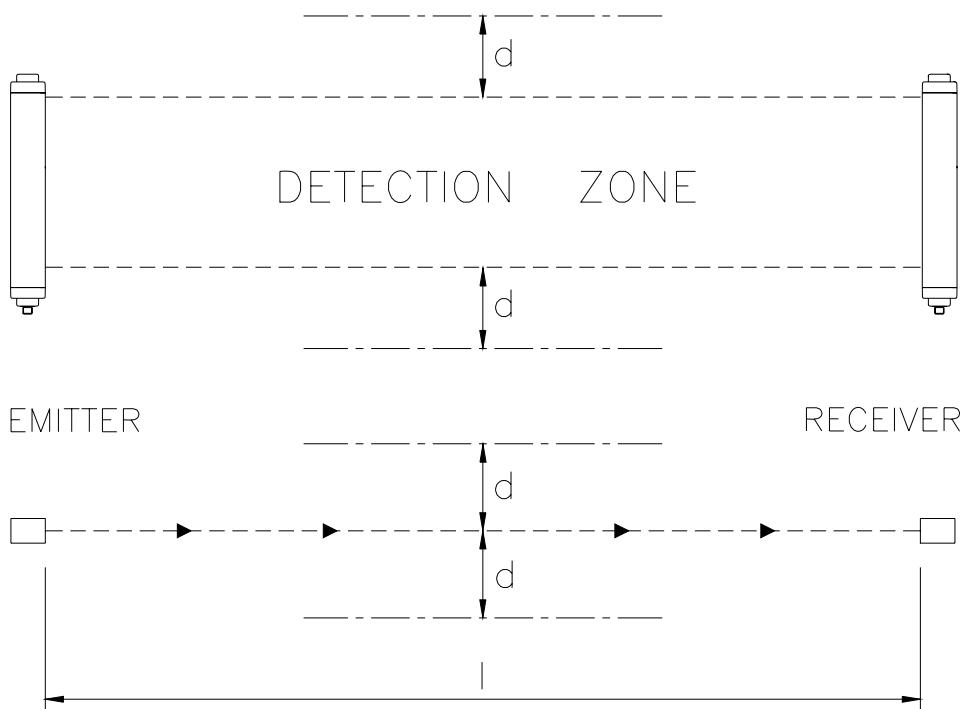
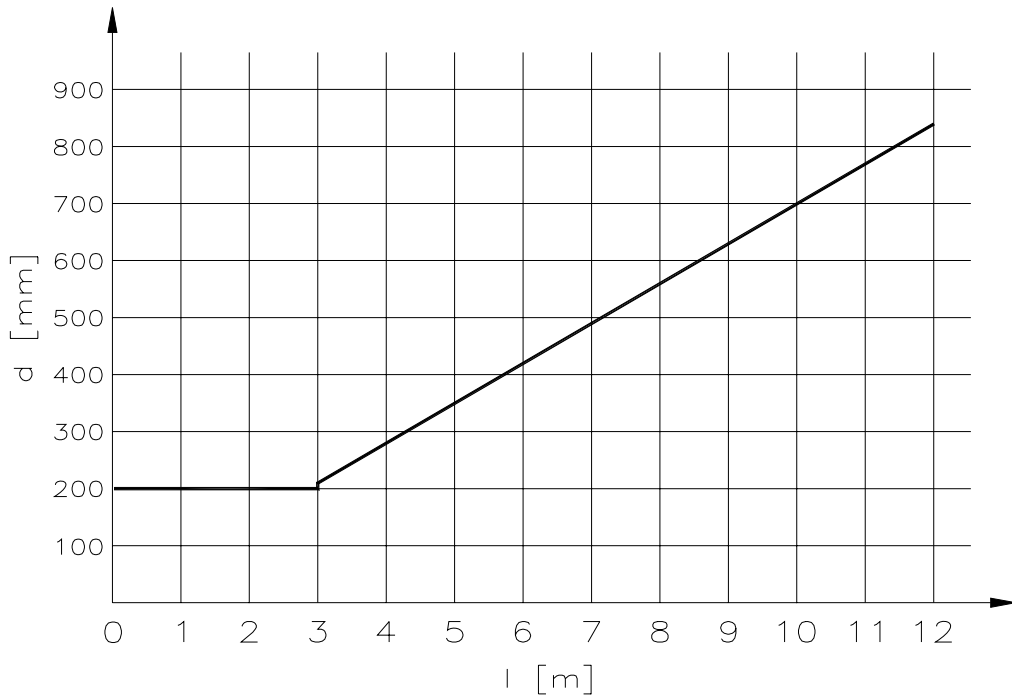

**Figure 13**

After installing the system, check whether any reflecting surfaces intercept the beams, first in the centre and then close to the Emitter and Receiver.

During these operations, the red LED on the Receiver should never, for any reason, switch off.

## USE OF DEFLECTION MIRRORS

In order to protect or control areas that can be accessed from more than one side, in addition to the Emitter and Receiver, one or more deflection mirrors can be installed.

These mirrors enable the optical beams generated by the Emitter to be deviated on one or more sides.

If the beams emitted by the Emitter must be deviated by 90°, the perpendicular to the surface of the mirror must form an angle of 45° with the direction of the beams.

The following figure illustrates an application in which two deviation mirrors are used to provide a U-shaped protection.

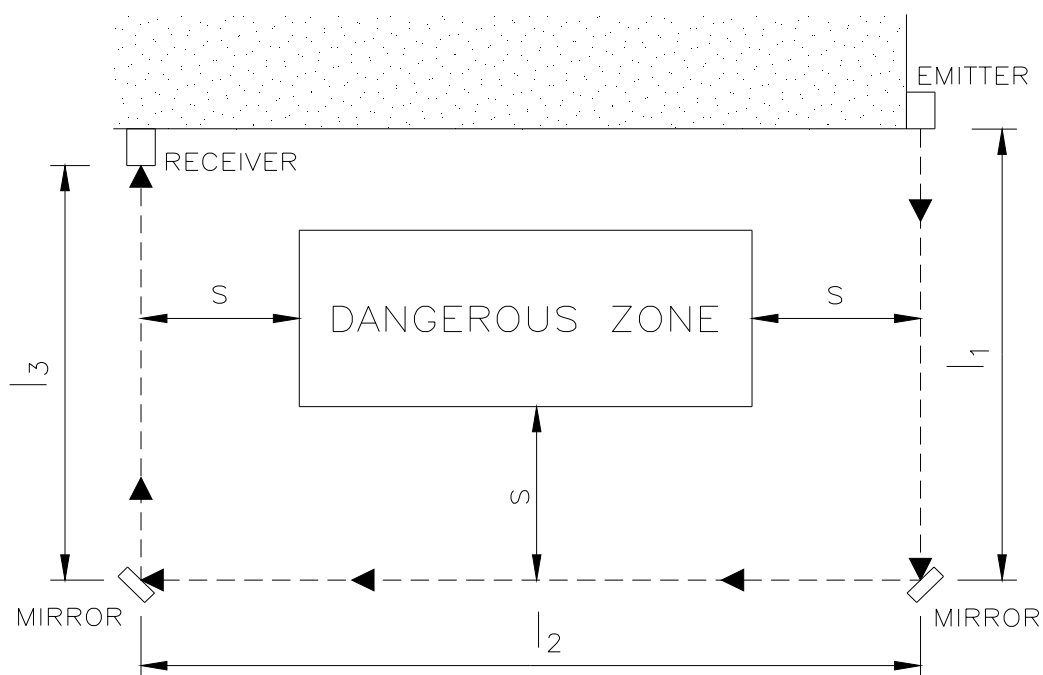

**Figure 14**

The following rules should be taken into consideration when using deviation mirrors:

- Place the mirrors so as to ensure compliance with the minimum safety distance **S** (Figure 14) on each side from which the danger zone can be accessed.
- The working distance (range) is given by the sum of the lengths of all the sides that give access to the protected area. (Remember that for each mirror used the maximum working range between the Emitter and the Receiver is reduced by 15%).
- During installation, take great care to avoid twisting along the longitudinal axis of the mirror.
- Make sure, by standing near to and on the axis of the Receiver, that the **entire outline** of the Emitter is visible on the first mirror.
- The use of more than three deviation mirrors is not recommended.



## MECHANICAL ASSEMBLY AND OPTIC ALIGNMENT

The Emitter and the Receiver must be assembled opposite each other (at a distance specified in the technical data sheet). Use the **fastening brackets and inserts** supplied with the system to place the Emitter and the Receiver so that these are aligned and parallel to each other and with the connectors facing the same way.

Depending on the dimensions and the shape of the support on which they are to be installed, the Emitter and Receiver must be assembled with the fastening inserts at the back, or else by fitting these in the side groove (Figure 15).

Perfect alignment of the Emitter and Receiver is essential in order to assure correct barrier operation. The indicator LEDs on the Emitter and Receiver facilitate this operation.

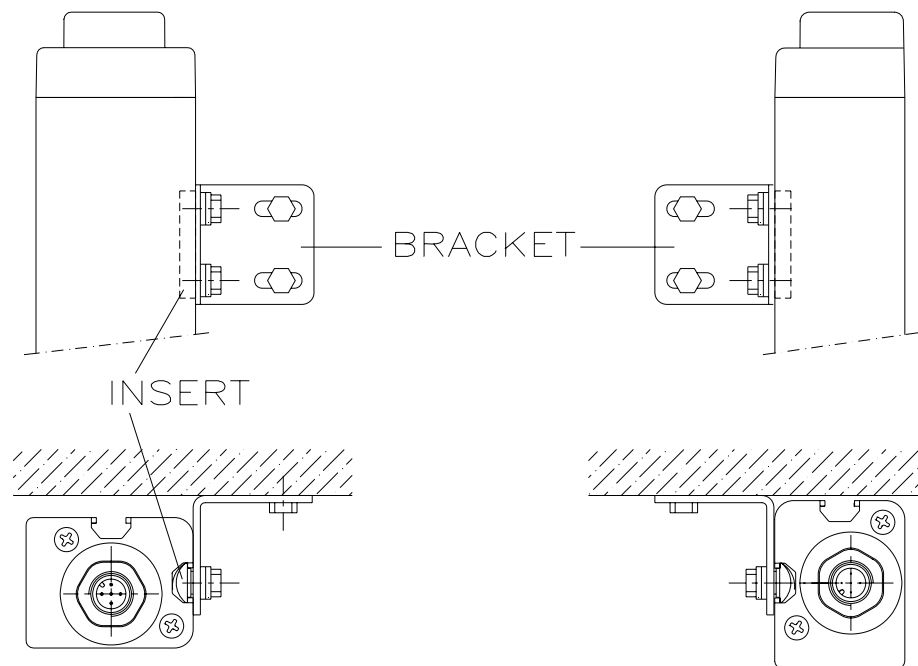

**Figure 15**

- Position the optical axis of the first and last beam of the Emitter on the same axis as that of the corresponding beams on the Receiver.
- Move the Emitter in order to find the area within which the green LED on the Receiver stays on, then position the first beam of the Emitter (the one close to the indicator LEDs) in the centre of this area.
- Using this beam as a pivot, effect small sideways movements of the opposite end to move to the protected area clear condition. The green LED on the Receiver will indicate this condition.
- Lock the Emitter and Receiver in place.

During these operations it may be useful to check the **yellow weak signal LED** on the Receiver. Upon completion of alignment, this LED must be off.

If the Emitter and the Receiver are assembled in areas that are subject to strong vibrations, the use of vibration-damping supports is recommended, in order to prevent circuit malfunctions.

**OPERATION AND TECHNICAL DATA**

**SIGNALS**

	LED	COLOUR	STATUS	CONDITION
<b>Emitter</b>	1	Yellow	On	System activated. Initial TEST.
	2	Red	On	
	1	Yellow	On	TEST condition
	3	Green	On	
	3	Green	On	Normal operation

	LED	COLOUR	STATUS	CONDITION
<b>Receiver</b>	4	Yellow	On	System activated
	5	Red	On	
	6	Red	On	
	7	Green	On	Protected area clear
	5	Red	On	Protected area engaged
	4	Yellow	On	Weak signal received

**NOTE:** For a description of the signalings in case of FAIL, please refer to the “TROUBLESHOOTING” paragraph in this manual (page 23).

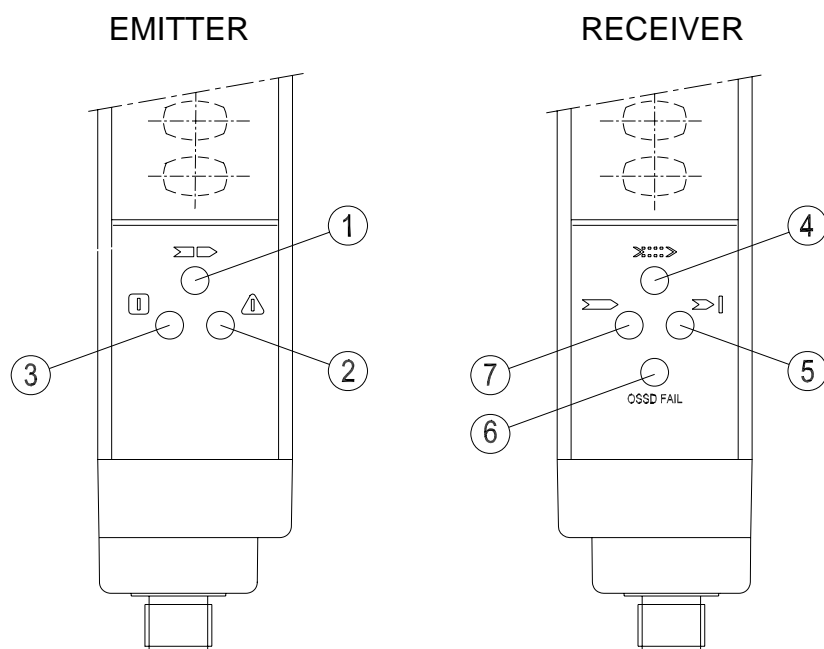

**Figure 16**

**➔** On the emitter of the multibeam models, near each beam, is present a red led which permits an easy detection of the beam.

TEST FUNCTION

**⚠** *The VISION light curtain does not dispose of a start/restart interlock circuit. In most applications this safety function is necessary. The safety relay VISION AD SR1 permits to implement this function in a safe way according to IEC 61496-1. Please consider the risk-analysis of your application about this matter.*

The VISION barrier system features an automatic self-diagnosis function that enables it to detect response time malfunctions (in an execution time less than **500ms**). This safety system is permanently active and does not require any interventions from the outside.

The TEST function is available (bringing to 0Vdc the voltage on the **pin 2** of the emitter) should the user wish to check equipment connected downstream of the barrier (without physically entering the protected area).

By means of the test function, which simulates occupation of the protected area, it possible to verify the operation of the entire system by means of an external supervisor (e.g. PLC, control module, etc.).

**The minimum duration of the TEST function must be 80 msec.**

By means of this function the OSSDs can be switched from ON to OFF as long as the function remains active.

OUTPUTS STATUS

The VISION features two static PNP outputs on the Receiver, the status of which depends on the condition of the protected area.

The maximum load allowed is 500mA at 24VDC, which corresponds to a resistive load of 48Ω. Maxim load capacity corresponds to 2.2μF. The meaning of the status of outputs is defined in the table below. Any short circuit between outputs or between outputs and 24VDC or 0VDC power supplies is detected by the barrier.

NAME OF SIGNAL	CONDITION	MEANING
OSSD1	24VDC	Barrier clear condition
OSSD2		
OSSD1	0VDC	Barrier engaged condition or failure detected
OSSD2		

Table 4

**⚠** *In the protected area clear condition, the Receiver supplies a voltage of 24 VDC on both outputs. The required load must therefore be connected between the output terminals and the 0VDC (Figure 17).*

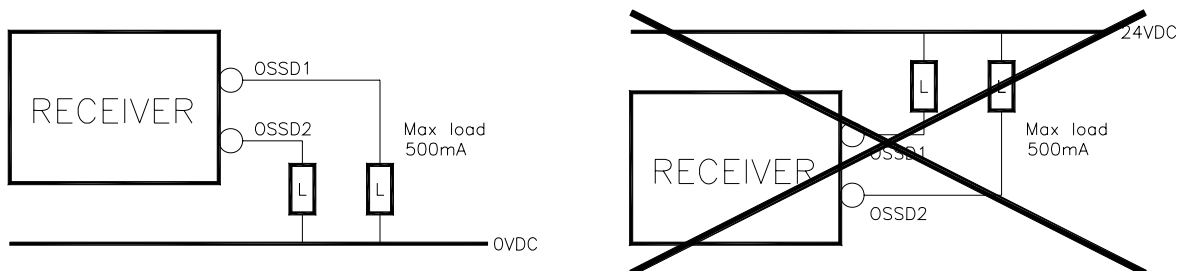

Figure 17

**TECHNICAL SPECIFICATIONS**

TECHNICAL SPECIFICATIONS OF VISION BARRIERS		
Protected height	mm	160 – 1810
Resolutions	mm	20 – 30 – 40 – 50 – 90
Working range	m	0 ÷ 6 (low) 1 ÷ 16 (high)
	models VL	
models VH		
Safety outputs		2 PNP – 500mA @24VDC
Response time	ms	(see tables for specific models)
Internal test execution time	ms	500
Power supply	Vdc	24 ± 20%
Connections		Connectors M12 5-pole
Max. conn. length	m	100
Operating temp.	°C	0 ÷ 55 °C
Protection rating		IP 65
Dimensions of section	mm	35 x 45
Max. consumption	W	2 (Emitter)      3 (Receiver)
Light curtain lifetime		20 years
Safety level	Type 2	IEC 61496-1:2004 IEC 61496-2:2006
	SIL 2	IEC 61508:1998
	SILCL 2	IEC 62061:2005
	PL d - Category 2	ISO 13849-1:2006

Models VL/VH Resolution 20 mm	152	302	452	602	752	902	1052	1202	1352	1502	1652	1802
Number of beams	15	30	45	60	75	90	105	120	135	150	165	180
Response time	7	8,5	10,5	12,5	14,5	16,5	18	20	22	24	26	28
Overall barrier ht. mm	261	411	561	711	861	1011	1161	1311	1461	1611	1761	1911
PFHd *	1,02E-8	1,17E-8	1,33E-8	1,48E-8	1,63E-8	1,79E-8	1,94E-8	2,10E-8	2,25E-8	2,40E-8	2,56E-8	2,71E-8
DCavg #	97,77%	98,07%	98,25%	98,38%	98,47%	98,53%	98,58%	98,63%	98,66%	98,69%	98,71%	98,73%
MTTFd # years	100					92,14	81,96	73,80	67,12	61,55	56,83	52,79
CCF #	80%											

Models VL/VH Resolution 30 mm	153	303	453	603	753	903	1053	1203	1353	1503	1653	1803
Number of beams	8	16	24	32	40	48	56	64	72	80	88	96
Response time	6	7	8	9	10	11	12	13	14	15	16	17
Overall barrier ht. mm	261	411	561	711	861	1011	1161	1311	1461	1611	1761	1911
PFHd *	9,58E-9	1,05E-8	1,14E-8	1,24E-8	1,33E-8	1,42E-8	1,51E-8	1,61E-8	1,70E-8	1,79E-8	1,88E-8	1,98E-8
DCavg #	97,58%	97,84%	98,02%	98,16%	98,26%	98,34%	98,40%	98,45%	98,50%	98,53%	98,57%	98,59%
MTTFd # years	100								99,34	91,93	85,55	79,99
CCF #	80%											

\* IEC 61508

# ISO 13849-1

Models VL/VH Resolution 40 mm	304	454	604	754	904	1054	1204	1354	1504	1654	1804
Number of beams	10	15	20	25	30	35	40	45	50	55	60
Response time	6	7	7,5	8	8,5	9,5	10	10,5	11	12	12,5
Overall barrier ht. mm	411	51	711	861	1011	1161	1311	1461	1611	1761	1911
PFHd *	1,01E-8	1,09E-8	1,17E-8	1,24E-8	1,32E-8	1,39E-8	1,47E-8	1,54E-8	1,62E-8	1,69E-8	1,77E-8
DCavg #	97,76%	97,93%	98,06%	98,16%	98,24%	98,31%	98,37%	98,42%	98,46%	98,49%	98,52%
MTTFd # years	100										93,89
CCF #	80%										

Models VL/VH Resolution 50 mm	305	455	605	755	905	1055	1205	1355	1505	1655	1805
Number of beams	8	12	16	20	24	28	32	36	40	44	48
Response time	6	6,5	7	7,5	8	8,5	9	9,5	10	10,5	11
Overall barrier ht. mm	411	561	711	861	1011	1161	1311	1461	1611	1761	1911
PFHd *	1,00E-8	1,07E-8	1,14E-8	1,21E-8	1,28E-8	1,35E-8	1,42E-8	1,49E-8	1,56E-8	1,63E-8	1,70E-8
DCavg #	97,72%	97,89%	98,02%	98,12%	98,21%	98,28%	98,33%	98,38%	98,43%	98,46%	98,49%
MTTFd # years	100										99,66
CCF #	80%										

Models VL/VH Resolution 90 mm	309	459	609	759	909	1059	1209	1359	1509	1659	1809
Number of beams	5	7	9	11	13	15	17	19	21	23	25
Response time	5,5	6	6	6	6,5	7	7	7	7,5	8	8
Overall barrier ht. mm	411	561	711	861	1011	1161	1311	1461	1611	1761	1911
PFHd *	9,78E-9	1,04E-8	1,09E-8	1,15E-8	1,21E-8	1,27E-8	1,32E-8	1,38E-8	1,44E-8	1,50E-8	1,55E-8
DCavg #	97,65%	97,81%	97,93%	98,04%	98,12%	98,19%	98,25%	98,30%	98,35%	98,39%	98,42%
MTTFd # years	100										
CCF #	80%										

Multibeam Models		V2BL / V2BH	V3BL / V3BH	V4BL / V4BH
Number of beams		2	3	4
Distance between beams mm		500	400	300
Response time ms		6	6	6
Overall barrier ht. mm		711	1011	1111
PFHd *		8,97E-9	9,15E-9	9,32E-9
DCavg #		97,30%	97,40%	97,49%
MTTFd # years		100		
CCF #		80%		

\* IEC 61508

# ISO 13849-1

**DIMENSIONS (in mm)**

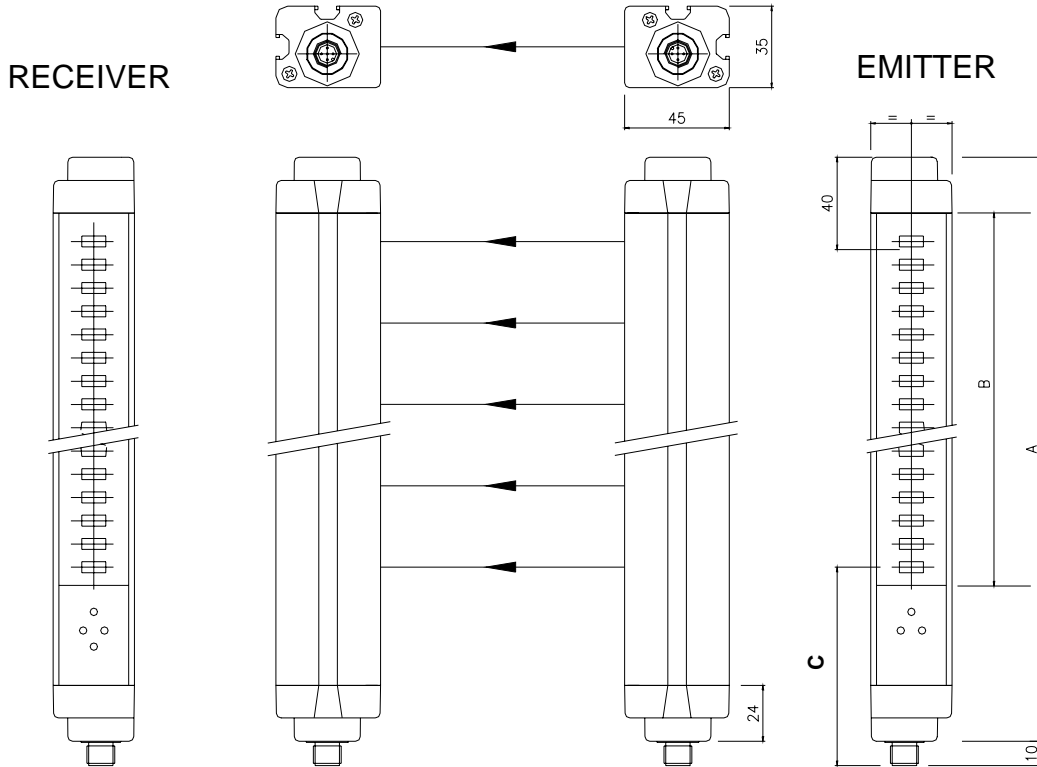

**Figure 18**  
**Emitter and Receiver**

Model VL/VH	150	300	450	600	750	900	1050	1200	1350	1500	1650	1800
<b>A</b>	251	401	551	701	851	1001	1151	1301	1451	1601	1751	1901
<b>B (PROTECTED AREA)</b>	160	310	460	610	760	910	1060	1210	1360	1510	1663	1810
<b>C</b>	85											
<b>Mounting</b>	2 LS Brackets with 2 mounting inserts						3 LS Brackets with 3 mounting inserts					

Model	V2BL / V2BH	V3BL / V3BH	V4BL / V4BH
<b>A</b>	701	1001	1101
<b>B</b>	610	910	1010
<b>C</b>	135		

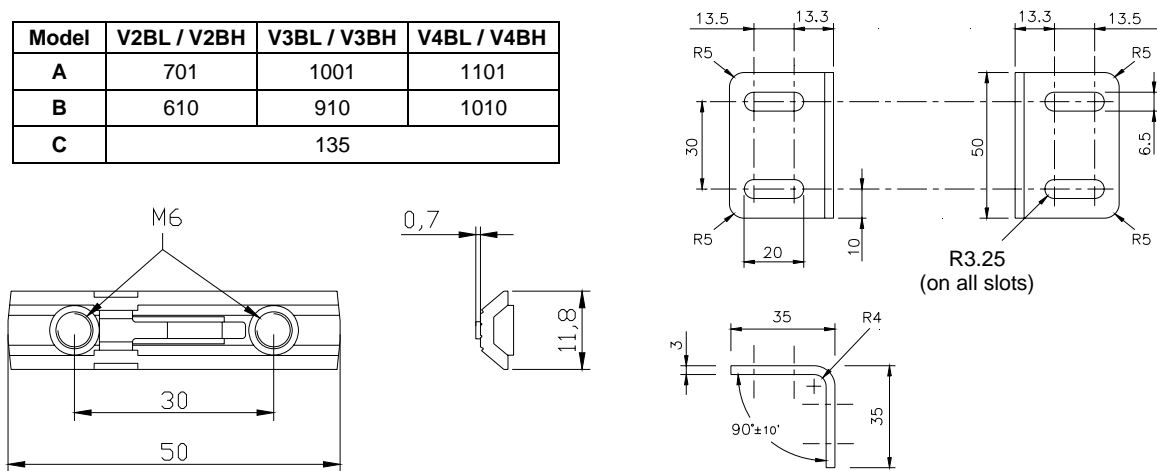

**Figure 19**  
**Fastening LS type brackets and inserts (included)**

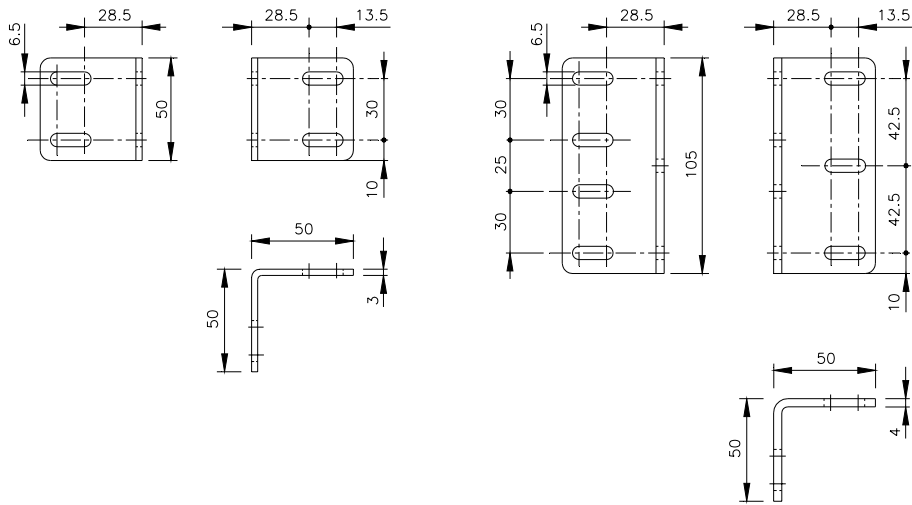

**Figure 20**  
**LL and LH TYPE fastening brackets (optional)**

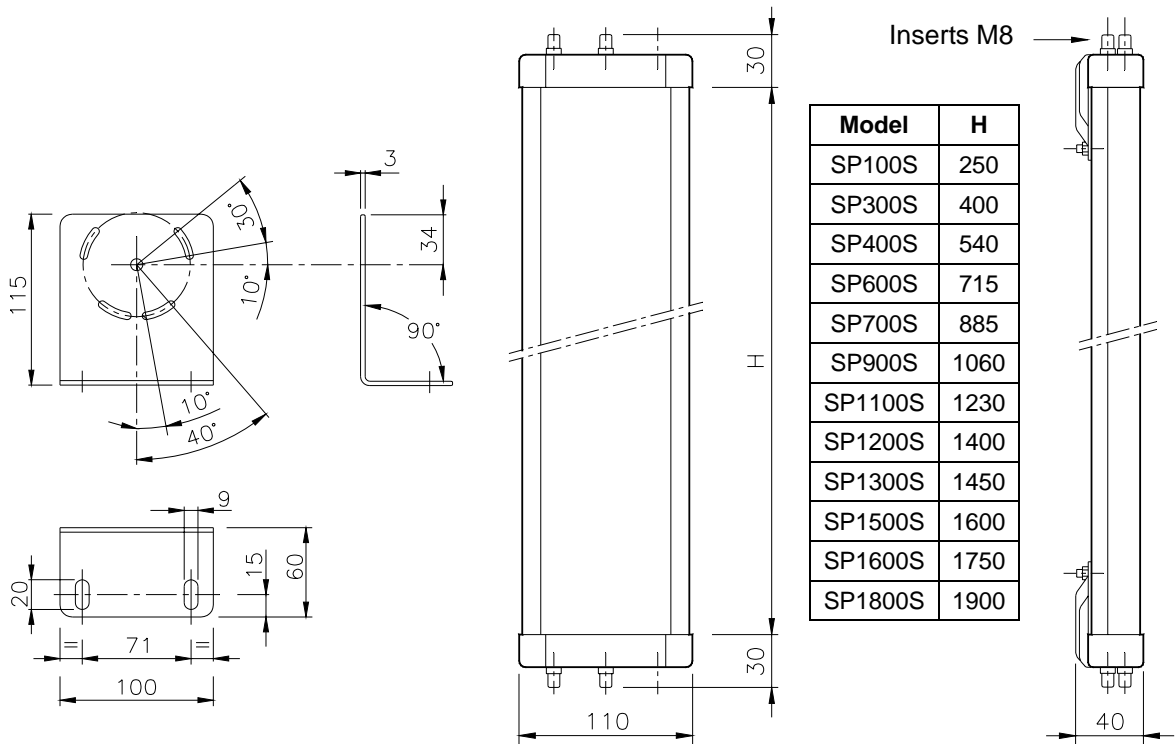

**Figure 21**  
**Fastening brackets for deviation mirrors**

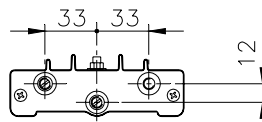

**Figure 22**  
**Deviation mirrors**

## CHECKOUTS AND MAINTENANCE

### Verification of barrier efficiency.



**Before each work shift or before switching on, check the correct operation of the photoelectric barrier.**

Proceed as follows, intercepting the beams using the appropriate test object (available on request).



**The correct test object must be used for testing, depending on the barrier resolution. Please see page 23 for the correct ordering code.**

Refer to Figure 23:

- Introduce the test object into the protected area and move it slowly, starting from the top and moving down (or vice versa), first in the centre and then close to both Emitter and Receiver.
- **Multibeam models:**
- Intercept each beam with an opaque object, first in the center of the detection zone and then close to the emitter and the receiver.
- Make sure that during each stage of the test object's movements the red LED on the Receiver is always on.

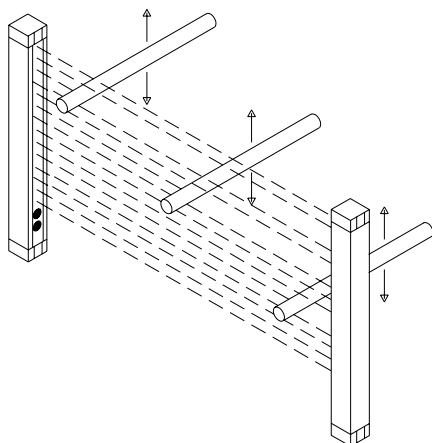

**Figure 23**

The VISION barrier does not require any specific maintenance operations; however, periodic cleaning of the front protective surfaces of the Emitter and Receiver optics is recommended.

Wipe using a clean, damp cloth; in particularly dusty environments, after cleaning the front surface, the use of an anti-static spray is recommended.

**Never use abrasive or corrosive products, solvents or alcohol**, which could damage parts. Do not use woollen cloths, that could electrify the front surface.



**Grooving or fine scratching of the front plastic surfaces can increase the amplitude of the emission angle of the light curtain, jeopardising detection efficiency in the presence of lateral reflecting surfaces.**



**It is therefore fundamental to pay particular attention during the cleaning phases of the curtain front window, especially in environments where abrasive dusts are present. (E.g. cement factories, etc).**

If the yellow weak signal LED on the Receiver switches on (LED 5 in Figure 16), check that:

- the front surfaces are clean;
- the Emitter and Receiver are aligned correctly.

If the LED stays on, contact the REER service department.



**TROUBLESHOOTING**

The instructions provided by the LEDs of the Emitter and the Receiver enable the user to identify the cause of a number of system malfunctions.

Refer to figure 24 to verify the LEDs indications.

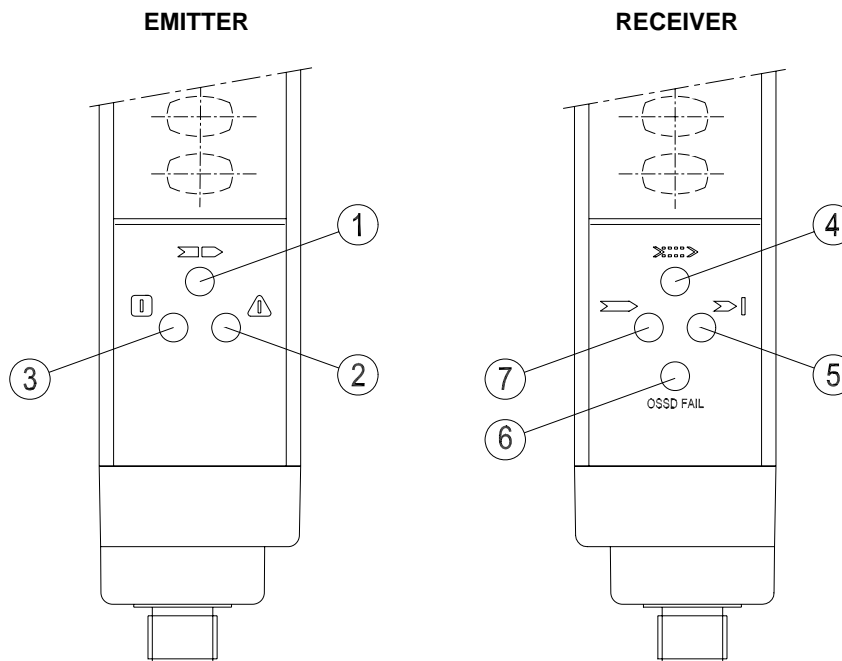

**Figure 24**

**EMITTER**

<b>LED</b>			<b>DIAGNOSIS</b>	<b>REMEDY</b>
<b>Yellow (1)</b>	<b>Red (2)</b>	<b>Green (3)</b>		
OFF	ON	OFF	Anomalous operation	Return the equipment to Reer laboratories for repair.

**RECEIVER**

<b>LED</b>				<b>DIAGNOSIS</b>	<b>REMEDY</b>
<b>Yellow(4)</b>	<b>Red (5)</b>	<b>Red (6)</b>	<b>Green (7)</b>		
Blinking <b>FAST</b> every 0,5s	ON	Blinking <b>FAST</b> every 0,5s	OFF	Internal failure relating to the microcontroller boards	Return the equipment to ReeR laboratories for repair.
OFF	ON	Blinking <b>FAST</b> every 0,5s	OFF	Internal failure relating to the static outputs (OSSD), or erroneous connection of static outputs (OSSD).	Check the connection of terminals 2 and 4 (OSSD) on the connector carefully. If no remedy is achieved: Return the equipment to ReeR laboratories for repair.
Blinking <b>FAST</b> every 0,5s	ON	OFF	OFF	Internal failure relating to the optical boards	Return the equipment to ReeR laboratories for repair.
OFF	ON	Blinking <b>SLOW</b> every 1s	OFF	Overcurrent on one or both outputs (OSSD) or Probable short circuit between the two outputs (OSSD)	Check the connection of terminals 2 and 4 (OSSD) on the connector carefully. If necessary, reduce the load by reducing the requested current to max. 500mA (2.2 µF).  These terminals can be connected directly to + 24 Vdc or to 0 Vdc or in short circuit.
Blinking <b>SLOW</b> every 1s	ON	OFF	OFF	Detection of a hazardous interfering Emitter condition. The Receiver is able to receive the beams emitted by two different Emitters at the same time.  <i>(This fault is displayed for at least 30 seconds).</i>	Locate the Emitter that is the cause of the disturbance and proceed as follows: <ul style="list-style-type: none"> <li>• Invert the positions of the Emitter and Receiver</li> <li>• Move the interfering Emitter to prevent this from illuminating the Receiver</li> <li>• Use opaque guards to shield the beams coming from the interfering Emitter</li> </ul>

In any case, when faced with a system stoppage, switch the system off and then on again, to exclude any occasional electromagnetic disturbances.

Should the problem persist after carrying out the checks described above, contact REER's service department. In case of continued malfunctioning:

- verify the integrity of electrical connections and check that these have been made correctly;
- check that the supply voltage levels comply with those specified in the technical data sheet;
- the barrier power supply should be kept separate from that of the other electric power equipment (electric motors, inverters, frequency converters) or other sources of disturbance.
- make sure that the Emitter and the Receiver are correctly aligned and that the front surfaces are perfectly clean.



***If it is not possible to clearly identify the malfunction and to remedy it, stop the machine and contact Reer's Assistance Service.***

If correct system operation cannot be restored after carrying out the above procedures, send the equipment to REER's laboratories, complete with all parts, stating clearly:

- the product code number (the **P/N** field is shown on the product label)
- serial number (the **S/N** field is shown on the product label)
- date of purchase;
- period of operation;
- type of application;
- fault.

## SPARE PARTS

MODEL	ARTICLE	CODE
AD SR1	AD SR1 Safety Relay	1330900
AD SR2	AD SR2 Safety Relay	1330901
CD5	Straight 5-pin M12 female connector, 5 m cable	1330950
CD95	90° 5-pin M12 female connector, 5 m cable	1330951
CD15	Straight 5-pin M12 female connector, 15 m cable	1330952
CD915	90° 5-pin M12 female connector, 15 m cable	1330953
CDM9	Straight 5-pin M12 female connector PG9	1330954
CDM99	90° 5-pin M12 female connector PG9	1330955
TR20	20mm diameter test rod	1330961
TR30	30mm diameter test rod	1330962
TR40	40mm diameter test rod	1330963
TR50	50mm diameter test rod	1330964
FB 4	Set of 4 fastening brackets	1330970
FB 6	Set of 6 fastening brackets	1330971
LL	Set of 4 fastening brackets LL type	7200037
LH	Set of 4 fastening brackets LH type	7200081
FI 4	Set of 4 fastening inserts	1330972
FI 6	Set of 6 fastening inserts	1330973
SFB	Set of 4 swivel fastening brackets	1330974
SAV-1	Set of 4 anti-vibration supports for LL/LS type brackets	1200084
SAV-2	Set of 6 anti-vibration supports for LH/LS type brackets	1200085

## GUARANTEE

All new VISION systems are guaranteed by REER for a period of 12 (twelve) months under normal working conditions, against defects due to faulty materials and workmanship.

During the aforesaid period, REER promises to replace faulty parts free of charge. This guarantee covers both material and labour.

REER reserves the right to decide whether to repair equipment or replace it with equipment of the same type or having the same characteristics.

The validity of this guarantee is subject to the following conditions:

- The user must notify REER of the fault within twelve months following the date of delivery of the product.
- The equipment and all parts thereof must be in the condition in which they were supplied by REER.
- The defect or malfunction must not arise directly or indirectly from:
  - Improper use
  - Non-observance of the instructions for use;
  - Negligence, inexperience, improper maintenance;
  - Repairs, modifications and adjustments carried out by personnel not authorised by REER, tampering, etc.;
  - Accidents or collisions (also during transportation or due to acts of God);
  - Other reasons for which REER cannot be held responsible.

Repairs will be carried out at REER's laboratories, to which the material must be consigned or forwarded: transport costs and any damage or loss of material during transportation will be charged to the Customer.

All replaced products and parts are property of REER.

REER does not recognise any other form of guarantee or rights other than those expressly stated above; no requests for compensation for damages incurred for costs, suspension of activities or any other events or circumstances related in any way to malfunctioning of the product or any parts thereof will be taken into consideration.

*In order to ensure the correct operation of the photoelectric barrier, careful and full compliance with all the rules, instructions and warnings stated in this manual is essential.*

*REER s.p.a. declines all responsibility for events arising from non-compliance with all or part of the aforesaid instructions.*

*Specifications subject to change without warning. • No part of this manual may be reproduced without the prior consent of REER.*